





Lever operated shears

● Lever operated shears type CLP

Shears for metal sheet, flat and round iron, L and T forms (depends on model)

Safety: return spring on the upper blade

Features	CLP1C	CLP2C	CLP4C	CLP6C	CLP7C	CLP9C	CLP10C
Lower blades length (mm)	125	150	200	250	300	200	175
Capacity soft steel S235JR (mm)	3,0	4,0	4,0	5,0	5,0	6,0	6,0
 (mm)	60 x 3	60 x 4	70 x 5	70 x 5	80 x 5	70 x 6	70 x 6
 (mm)	10	10	12	12	12	16	20
 (mm)	-	-	-	-	-	-	16
 (mm)	-	-	-	-	-	40 x 5	60 x 5
 (mm)	-	-	-	-	-	-	40 x 5
Weight (kg)	12	14	18	23	28	42	98

Model
CLP4C



● Hand corner notcher 90° ENC-150-15

Strong and reliable, the hand corner notcher, fixed angle, provides fast and easy right angle cutting, adjustable gauge with graduation

- Cutting angle 90°
- Capacity for soft steel S235JR: 1,5 mm
- Maximum notching: 150 mm x 150 mm
- Dimensions: 610 mm x 530 mm x 600 mm
- Weight: 95 kg

Model
ENC150-15

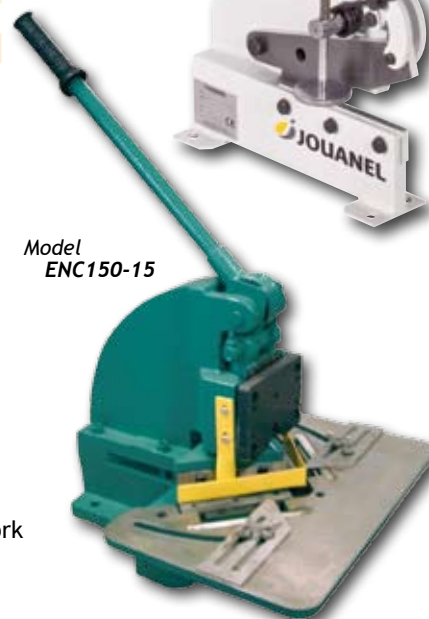

● CL1020-15C

The lever operated shears is an ideal workshop machine for zinc and light sheet metal work

Simple and easy layout cutting with blades visible

Lever flexibility for small dimensions cuts in high speed

- Interchangeable square stop
- Retractable manual sheet clamp with locking system
- Upper blade support balanced with weight
- Adjustment of the rack operated gauge by control wheel

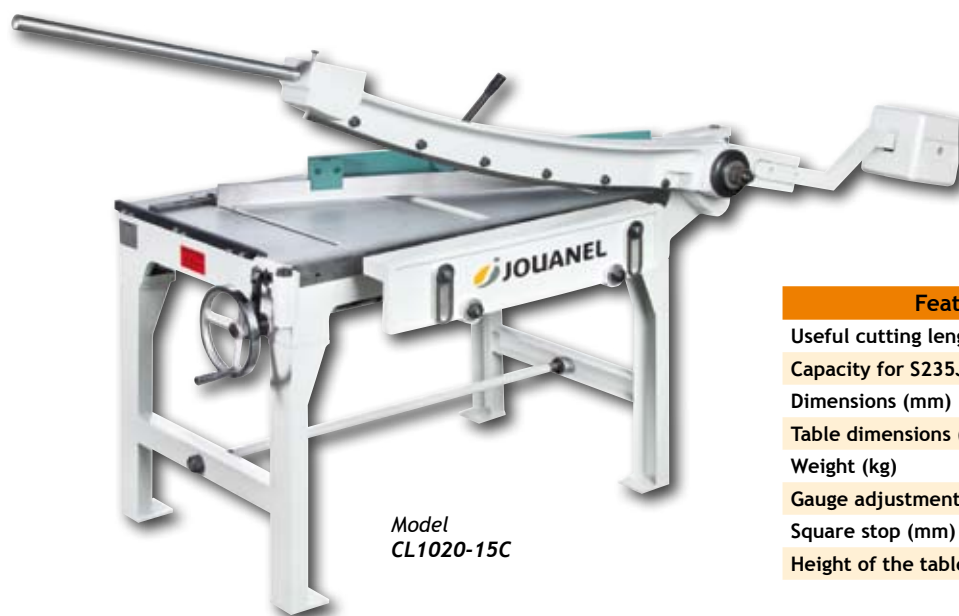

Model
CL1020-15C

Features	CL1020-15C
Useful cutting length (mm)	1020
Capacity for S235JR soft steel (mm)	1,5
Dimensions (mm)	2700 x 1300 x 1150
Table dimensions (mm)	1 000 x 700
Weight (kg)	380
Gauge adjustment (mm)	20-500
Square stop (mm)	700
Height of the table (mm)	780



Lever operated shears

● CL2030-10:

- Space saving with two sheet metal racks, width 750 mm
- Fast and precise adjustment of the rack operated gauge, direct access by the operator, wheel operated control with counter
- Upper blade support balanced with cylinder
- Table generously sized for use as a working table

Wheel operated control with counter for gauge adjustment



Features	CL2030-10
Useful cutting length (mm)	2030
Capacity for S235JR soft steel (mm)	1,0
Dimensions (mm)	3 000 x 1 350 x 1 800
Table dimensions (mm)	2 200 x 800
Weight (kg)	484
Gauge adjustment (mm)	40-500
Square stop (mm)	700
Height of the table (mm)	850



Model
CL2030-10



Jouanel Industrie S.A. | Z.A. des Saulniers | 37800 Sainte-Maure-de-Touraine | France
Tel. : +33 247.654.067 - Fax : +33 247.655.161 | info@jouanel.com | www.jouanel.com

With the aim to keep on improving its machinery, Jouanel reserves its right to modify machinery features at any time.